

Marderschlafkasten

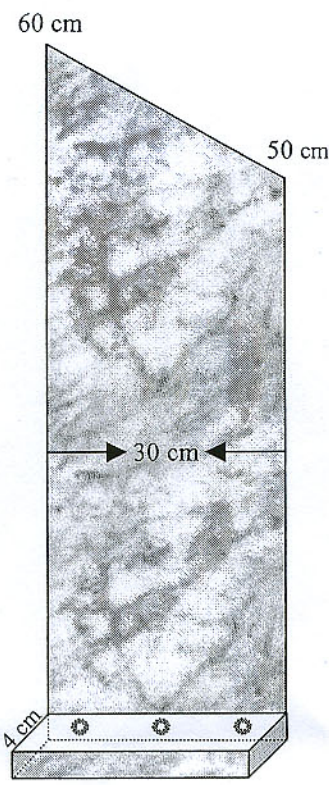

2 Seitenteile
mit
Halteleisten
für Boden

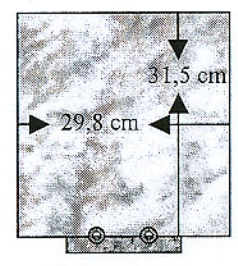
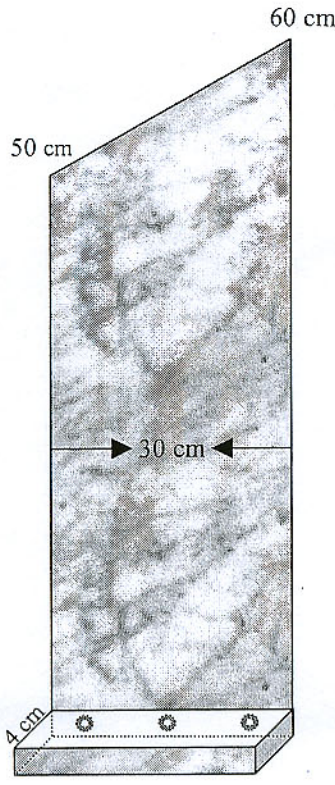

Bodenbrett mit
Griffholz 15 x 2,5 cm

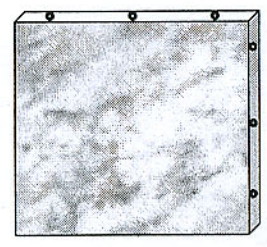

2 Trittbrettchen
15 x 15 cm

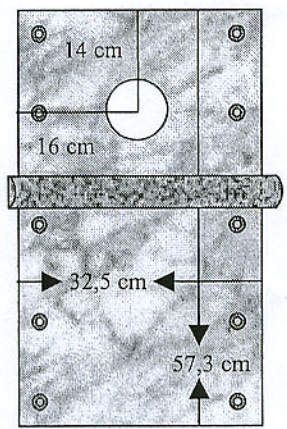

Vorderseite mit Loch 8 cm
Einschlupfholz 35 x 4 cm
angeflacht

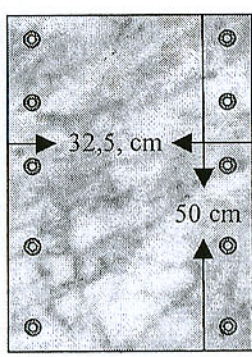

Rückwand

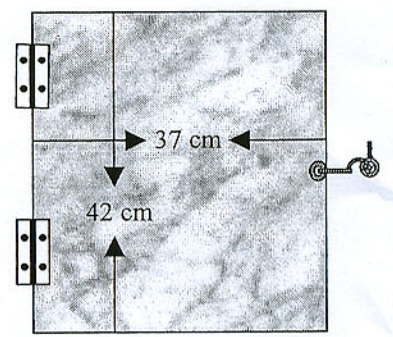

Deckel mit 2 Scharnieren
und Windhaken mit
2 Rundösen

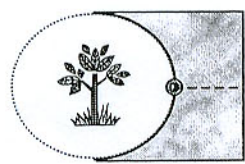

2 Abstandshalter
geringster Abstand 6 cm